

V_{RRM}	650V
I_F	20A ($T_C=148^{\circ}C$)
Q_C	62nC

650V SILICON CARBIDE
SCHOTTKY DIODE

◇ Features

- High surge current capability
- No reverse recovery
- Positive Temperature Coefficient
- Easy to paralleling
- Halogen-free / RoHS compliant



◇ Benefits

- High-speed switching
- Low heat dissipation requirements
- Reduce size and cost of the system
- High-reliability
- System efficiency improvement



TO-247AC

◇ Applications

- Solar inverter
- Power factor correction
- Data Center
- Switch mode power supply

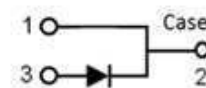

Maximum Ratings (Tc=25°C unless otherwise noted)

Symbol	Parameter		Value	Unit	Note
V_{RRM}	Repetitive peak reverse voltage		650	V	
I_F	Continuous forward current	Tc=25°C	54	A	Figure 3
		Tc=135°C	25	A	
		Tc=148°C	20	A	
I_{FSM}	Non-repetitive forward surge current	Tc=25°C, $t_p=10ms$, Half sine pulse	170	A	
		Tc=110°C, $t_p=10ms$, Half sine pulse	154	A	
I_{FRM}	Repetitive Peak Forward Surge Current	Tc=25°C, $t_p=10ms$, Half sine pulse	159	A	
$\int i^2 dt$	i^2t value	Tc=25°C, $t_p=10ms$	144	A ² S	
		Tc=110°C, $t_p=10ms$	118	A ² S	
P_{tot}	Power Dissipation	Tc=25°C	204	W	Figure 4
		Tc=110°C	88	W	
		Tc=150°C	34	W	
T_j, T_{stg}	Operating and Storage Temperature		-55 to +175	°C	

Electrical Characteristics (Tc=25°C unless otherwise noted)

Symbol	Parameter	Test Conditions	Value			Unit	Note
			Min.	Typ.	Max.		
V_{DC}	DC blocking voltage		650	-	-	V	
V_F	Forward voltage	$I_F=10A$	-	1.16	-	V	Figure 1
		$I_F=20A, T_c=25^\circ C$	-	1.35	1.6	V	
		$I_F=20A, T_c=175^\circ C$		1.7		V	
I_R	Reverse current	$V_R=650V, T_c=25^\circ C$	-	6	100	uA	Figure 2
		$V_R=650V, T_c=175^\circ C$		15		uA	
Q_C	Total capacitive charge	$V_R=400V$	-	62	-	nC	Figure 6
C	Total capacitance	$V_R=1V, f=1MHZ$	-	906	-	pF	Figure 5
		$V_R=200V, f=1MHZ$	-	122	-	pF	
		$V_R=400V, f=1MHZ$	-	118	-	pF	
E_C	Capacitance Stored Energy	$V_R=400V$	-	10	-	uJ	Figure 7

Thermal Characteristics

Symbol	Parameter	Value		Unit	Note
		Typ.	Max.		
$R_{th(j-c)}$	Thermal resistance (Junction to case)	0.735	-	°C/W	Figure 8

Electrical Characteristic Curves

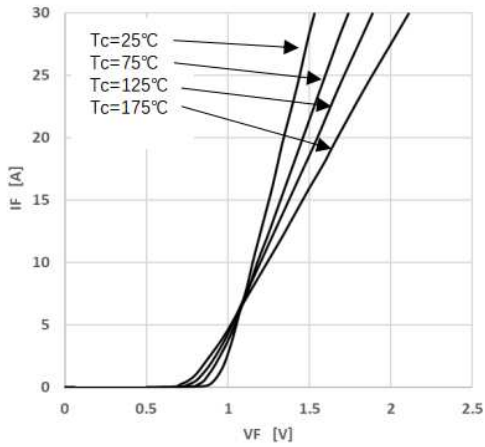

Figure 1 Forward Characteristics

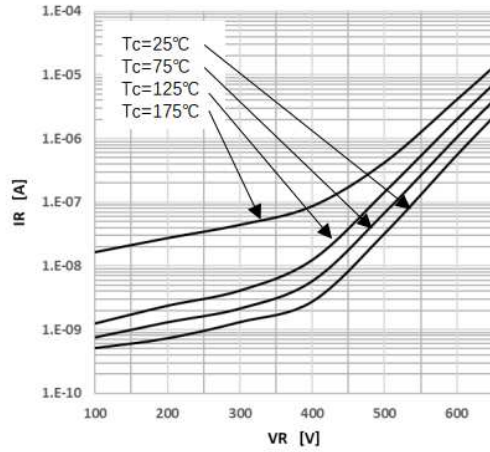

Figure 2 Reverse Characteristics

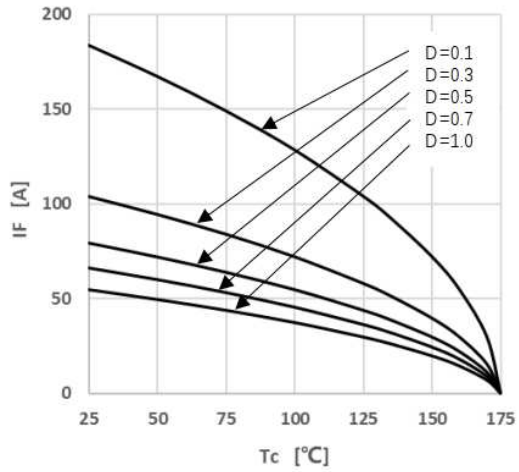

Figure 3 Peak Forward Current Derating

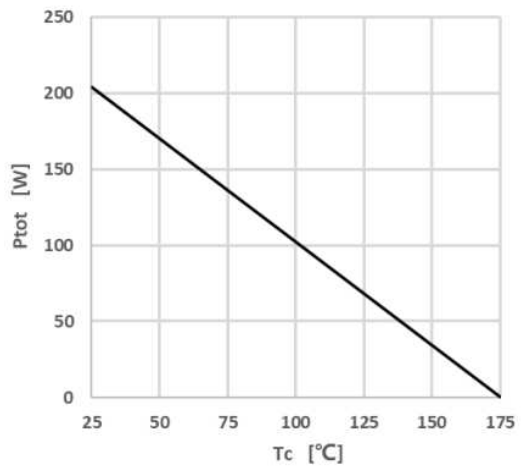

Figure 4 Power Dissipation

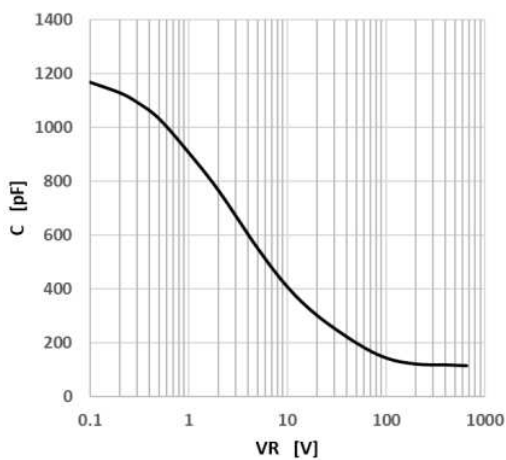

Figure 5 Capacitance vs. Reverse Voltage

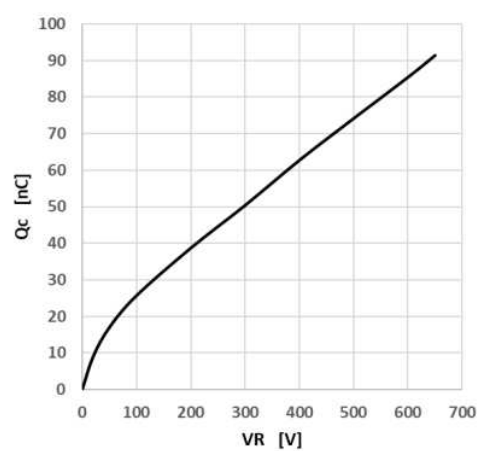

Figure 6 Capacitance Charge vs. Reverse Voltage

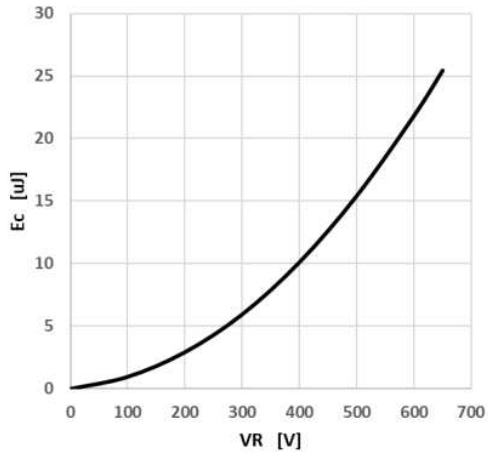

Figure 7 Capacitance Stored Energy

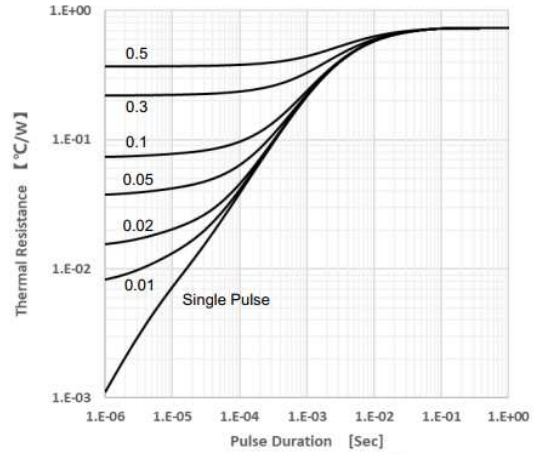
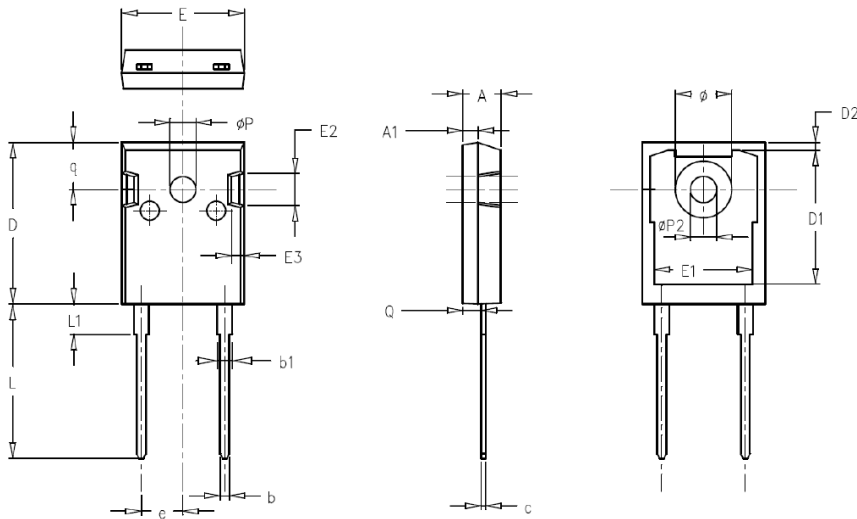

Figure 8 Transient Thermal Impedance

TO-247AC Package Dimensions : (Unit : mm)



SYMBOL	MILLIMETERS			NOTES	SYMBOL	MILLIMETERS			NOTES
	Normal	MIN.	MAX.			Normal	MIN.	MAX.	
A	4.98	4.68	5.36		øP	3.66	3.45	3.85	
A1	1.99	1.90	2.10		e	5.44	BSC		
Q	2.41	2.30	2.60		q	6.24	5.99	6.58	
c	0.60	0.48	0.72		øP2	3.45	3.24	3.64	
b	1.20	1.00	1.40		ø	7.14	7.10	7.30	
b1	2.07	1.90	2.30		D1	16.56	16.10	17.10	
D	21.10	20.80	21.80		D2	0.98	0.80	1.36	
E	15.98	15.38	16.20		E1	13.30	13.00	13.52	
L	20.28	19.50	20.50		E2	5.64	5.10	6.10	
L1	4.01	3.75	4.35		E3	2.33	1.90	2.70	

Notice

MOSPEC reserves the rights to make changes of the content herein the document anytime without notification. MOSPEC or anyone on its behalf, assumes no responsibility or liability for any errors or inaccuracies. Please refer to MOSPEC website for the last document.

MOSPEC disclaims any and all liability arising out of the application or use of any product including damages incidentally and consequentially incurred.

Application shown on the herein document are examples of standard use and operation. Customers are responsible for comprehending suitable use in particular applications. MOSPEC makes no representation or warranty that such application will be suitable for the specified use without further testing or modification.

The information contained herein is presented only as a guide for the applications of our products. No responsibility is assumed by MOSPEC for any infringements of patents or other rights of the third parties which may result from its use. No license is granted by implication or otherwise under any patent or patent rights of MOSPEC or others.

These MOSPEC products are intended for usage in general electronic equipment. Please make sure to consult with MOSPEC before you use these MOSPEC products in equipment which require specialized quality and/or reliability, and in equipment which could have major impact to the welfare of human life (atomic energy control, aeronautics , traffic control, combustion control, safety devices etc.)