

100V N-Channel Power SGT MOSFET

DESCRIPTION :

- Excellent $R_{DS(ON)}$
- Low Gate Charge
- 100% UIS Tested
- 100% ΔV_{ds} Tested
- RoHS compliant
- Halogen Free

V_{DSS}	100V
$I_D @ V_{GS}=10V$	54A
$R_{DS(ON_Typ.) @ V_{GS}=10V}$	12.8m Ω

TYPICAL APPLICATIONS :

- Power Management
- Load Switch
- PWM Application

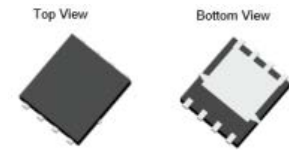

PDFN5x6-8

MAXIMUM RATINGS (at $T_C = 25^\circ C$, unless otherwise specified)

Characteristic	Condition	Symbol	Value	Unit
Drain-Source Voltage		V_{DS}	100	V
Gate-Source Voltage		V_{GS}	± 20	V
Continuous Drain Current	$T_C=25^\circ C$ $T_C=100^\circ C$	I_D	54 38	A
Pulsed Drain Current ⁽¹⁾		I_{DM}	Refer to Fig4	A
Single Pulsed Avalanche Energy ⁽²⁾		E_{AS}	74	mJ
Power dissipation	$T_C=25^\circ C$ $T_C=100^\circ C$	P_D	94 38	W
Junction & Storage temperature Range		T_J, T_{STG}	-55~+150	$^\circ C$

Notes : 1. Repetitive Rating: Pulse Width Limited by Maximum Junction Temperature.

2. EAS condition: Starting $T_J=25^\circ C$, $V_{DD}=50V$, $V_{GS}=10V$, $R_G=25\Omega$, $L=3mH$, $I_{AS}=7A$, $V_{DD}=0V$ during time in avalanche.

THERMAL CHARACTERISTICS

Characteristic	Condition	Symbol	Value	Unit
Thermal resistance,	Junction to Ambient	$R_{\theta JA}$	44	$^\circ C/W$
	Junction to Case	$R_{\theta JC}$	1.3	

ELECTRICAL CHARACTERISTICS (at $T_J = 25\text{ }^\circ\text{C}$, unless otherwise specified)

Characteristic	Symbol	Min.	Typ.	Max.	Unit
Drain-Source Breakdown Voltage VGS = 0V, ID = 250uA	$V_{(BR)DSS}$	100			V
Zero Gate Voltage Drain Current VDS = 80 V, VGS = 0 V	I_{DSS}			1	uA
Gate-Source Leakage Current VGS = ± 20 V, VDS = 0V	I_{GSS}			± 100	nA
Gate-Source threshold voltage VDS = VGS, ID = 250uA	$V_{GS(th)}$	1.2	1.8	2.3	V
Drain-Source On-State Resistance VGS = 10V, ID = 20A VGS = 4.5V, ID = 20A	$R_{DS(on)}$		12.8 18.2	16.7 23.6	m Ω
Input capacitance f=1MHz, VDS= 50 V, VGS=0 V	C_{iss}		969		pF
Output capacitance f=1MHz, VDS= 50 V, VGS=0 V	C_{oss}		329		pF
Reverse transfer capacitance f=1MHz, VDS= 50 V, VGS=0 V	C_{rss}		19		pF
Gate Resistance f=1MHz	R_g		1.5		Ω
Total Gate Charge VDS= 50V, ID= 20A, VGS= 0 to 10V	Q_G		18		nC
Gate to Source Charge VDS= 50V, ID= 20A, VGS= 0 to 10V	Q_{GS}		4		nC
Gate to Drain Charge VDS= 50V, ID= 20A, VGS= 0 to 10V	Q_{GD}		5		nC
Turn-on delay time VDD= 50 V, VGS= 10V, ID= 20A, $R_{GEN}=6.2\Omega$	$t_{d(ON)}$		8		ns
Rise time VDD= 50 V, VGS= 10V, ID= 20A, $R_{GEN}=6.2\Omega$	tr		19		ns
Turn-off delay time VDD= 50 V, VGS= 10V, ID= 20A, $R_{GEN}=6.2\Omega$	$t_{d(OFF)}$		22		ns
Fall time VDD= 50 V, VGS= 10V, ID= 20A, $R_{GEN}=6.2\Omega$	tf		9		ns

Body Diode

ELECTRICAL CHARACTERISTICS (at $T_J = 25\text{ }^\circ\text{C}$, unless otherwise specified)

Characteristic	Symbol	Min.	Typ.	Max.	Unit
Diode Forward Voltage $V_{GS} = 0V, I_S = 20A$	V_{SD}			1.2	V
Maximum Continuous Body Diode Forward Current	I_S			54	A
Maximum Pulsed Body Diode Forward Current	I_{SM}			217	A
Revers Recovery Time $I_F = 20A, di/dt = 100A/\mu s$	T_{rr}		32		ns
Revers Recovery Charge $I_F = 20A, di/dt = 100A/\mu s$	Q_{rr}		30.3		nC

Typical Performance Characteristics

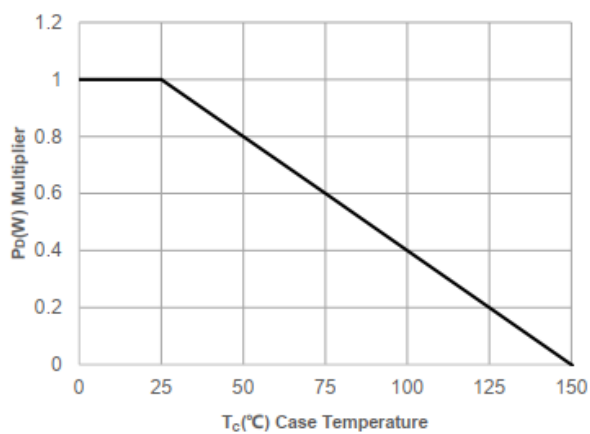

Figure 1. Power De-rating

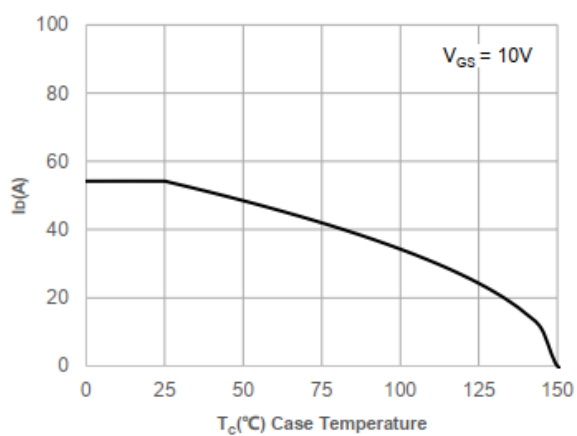

Figure 2. Current De-rating

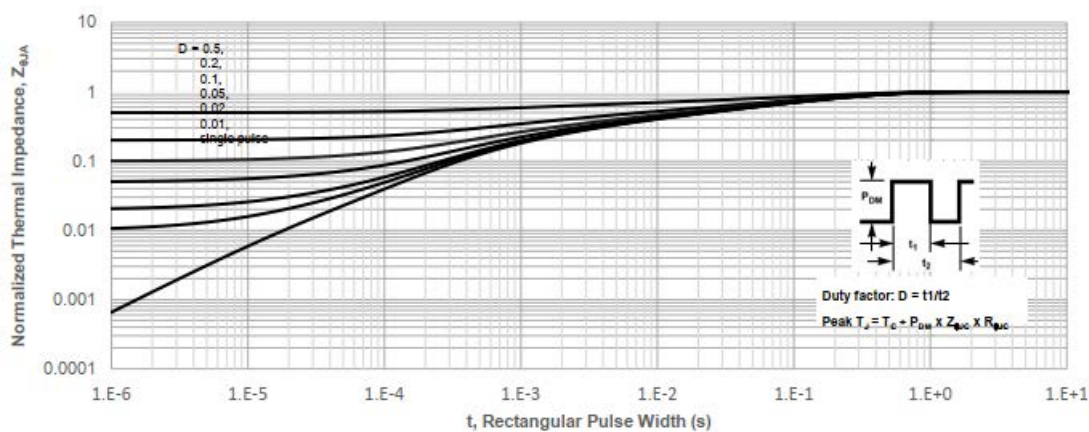

Figure 3. Normalized Maximum Transient Thermal Impedance

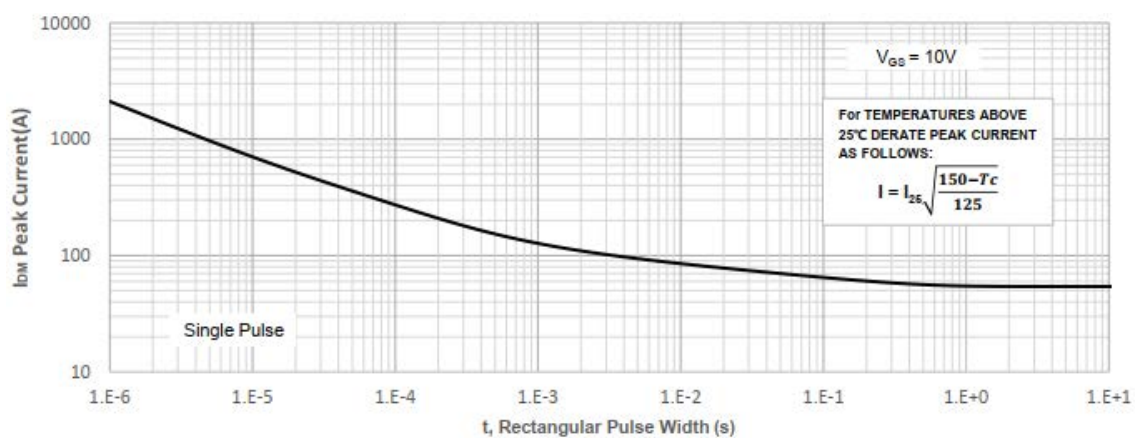

Figure 4. Peak Current Capacity

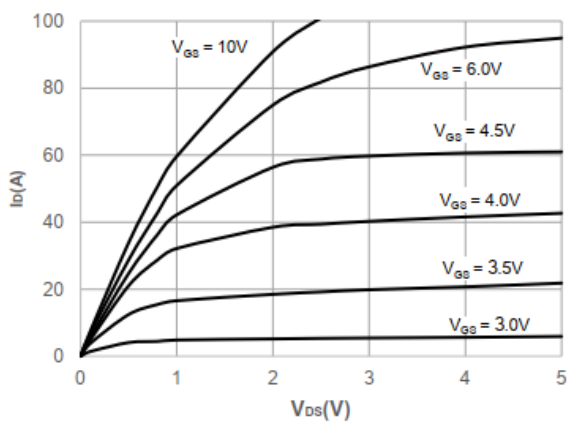

Figure 5. Output Characteristics

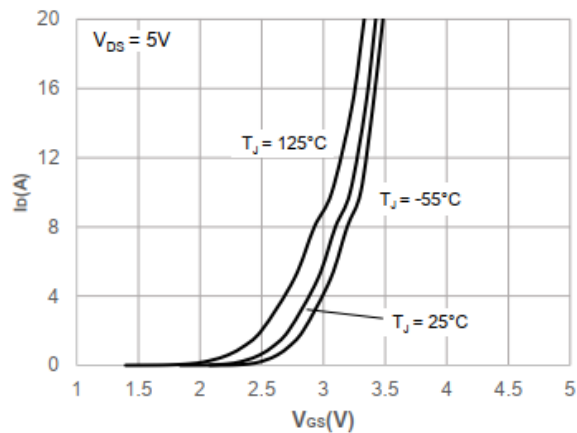

Figure 6. Typical Transfer Characteristics

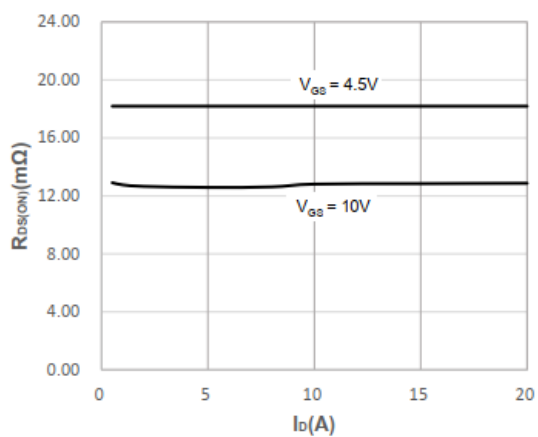

Figure 7. On-resistance vs. Drain Current

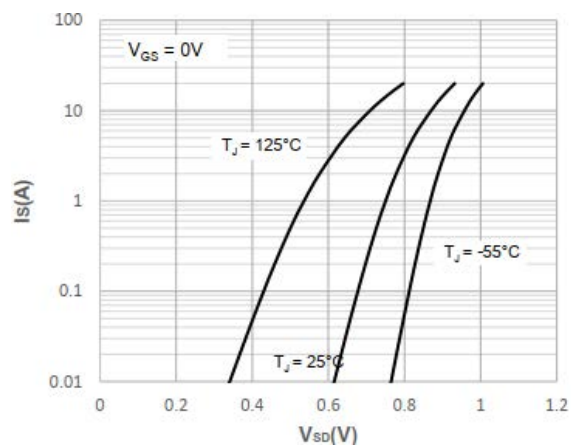

Figure 8. Body Diode Characteristics

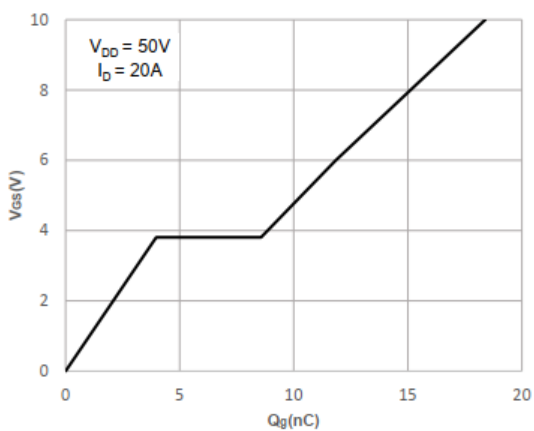

Figure 9. Gate Charge Characteristics

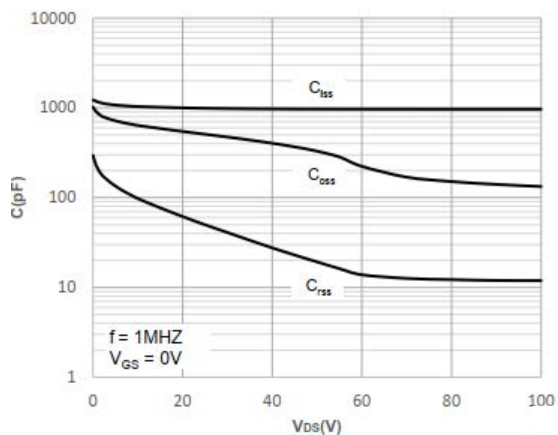

Figure 10. Capacitance Characteristics

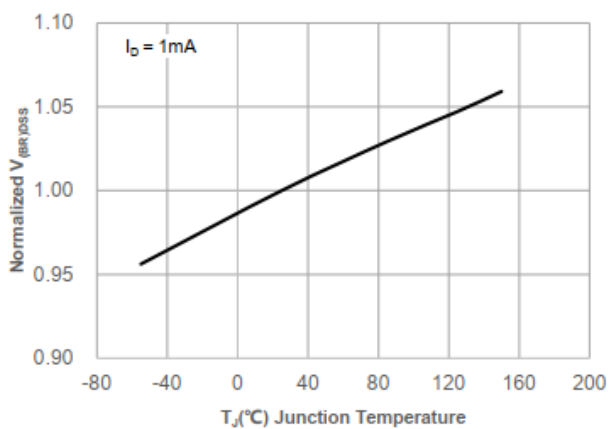

Figure 11. Normalized Breakdown voltage vs. Junction Temperature

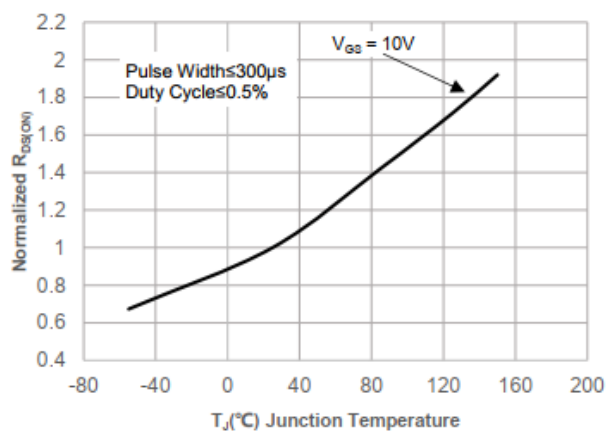

Figure 12. Normalized on Resistance vs. Junction Temperature

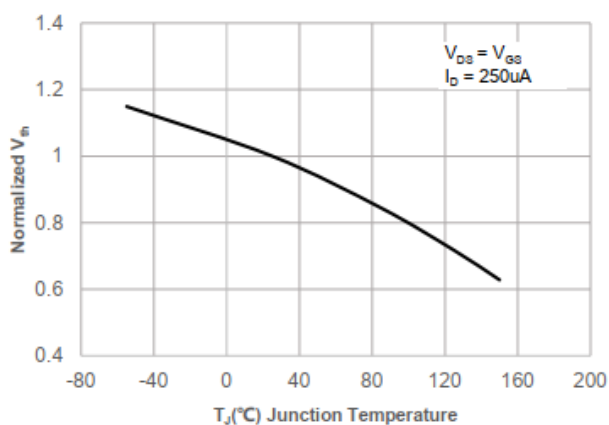

Figure 13. Normalized Threshold Voltage vs. Junction Temperature

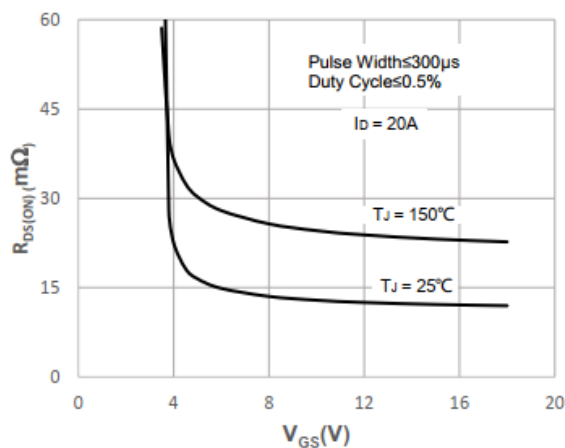

Figure 14. $R_{DS(ON)}$ vs. V_{GS}

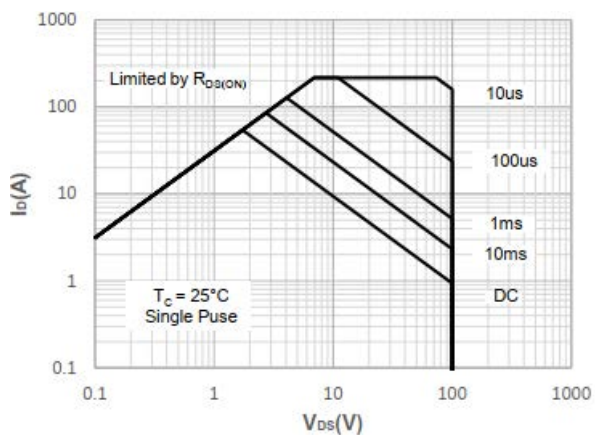
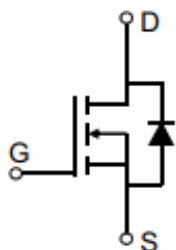
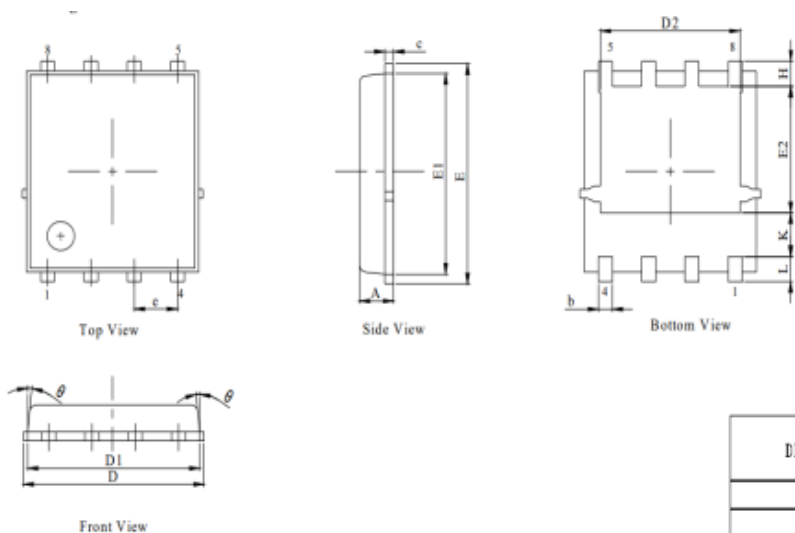

Figure 15. Maximum Safe Operating Area

• Circuit diagram



• Package outlines : Dimensions in (mm)



- NOTES:
1. Dimension and tolerance per ASME Y14.5M, 1994.
 2. All dimensions in millimeter (angle in degree).
 3. Dimensions D1 and E1 do not include mold flash protrusions or gate burrs.

DIM.	MILLIMETER		
	MIN.	NOM.	MAX.
A	0.9	1	1.15
b	0.31	0.41	0.51
C	0.24	0.32	0.4
D	5	5.2	5.4
D1	4.95	5.05	5.15
D2	4	4.1	4.2
E	6.05	6.15	6.25
E1	5.5	5.6	5.7
E2	3.42	3.53	3.63
e	1.27BSC		
H	0.6	0.7	0.8
L	0.5	0.7	0.8
K	1.23 REF		
0			10

Notice

MOSPEC reserves the rights to make changes of the content herein the document anytime without notification. MOSPEC or anyone on its behalf, assumes no responsibility or liability for any errors or inaccuracies. Please refer to MOSPEC website for the last document.

MOSPEC disclaims any and all liability arising out of the application or use of any product including damages incidentally and consequentially incurred.

Application shown on the herein document are examples of standard use and operation. Customers are responsible for comprehending suitable use in particular applications. MOSPEC makes no representation or warranty that such application will be suitable for the specified use without further testing or modification.

The information contained herein is presented only as a guide for the applications of our products. No responsibility is assumed by MOSPEC for any infringements of patents or other rights of the third parties which may result from its use. No license is granted by implication or otherwise under any patent or patent rights of MOSPEC or others.

These MOSPEC products are intended for usage in general electronic equipment. Please make sure to consult with MOSPEC before you use these MOSPEC products in equipment which require specialized quality and/or reliability, and in equipment which could have major impact to the welfare of human life (atomic energy control, aeronautics , traffic control, combustion control, safety devices etc.)