

NPN SILICON POWER TRANSISTORS

...designed for the output stage of 15W to 25W AF power amplifier

FEATURES:

- * Low Collector-Emitter Saturation Voltage
 $V_{CE(sat)} = 1.0V(\text{Max}) @ I_C = 2.0A, I_B = 0.2A$
- * DC Current Gain
 $hFE = 40-320 @ I_C = 1.0A$
- * Complementary to PNP 2SB507

**NPN
2SD313**

**3 AMPERE
POWER
TRANSISTORS
60 VOLTS
30 WATTS**

MAXIMUM RATINGS

Characteristic	Symbol	2SD313	Unit
Collector-Emitter Voltage	V_{CEO}	60	V
Collector-Base Voltage	V_{CBO}	60	V
Emitter-Base Voltage	V_{EBO}	5.0	V
Collector Current - Continuous	I_C	3.0	A
- Peak	I_{CM}	8.0	
Base current	I_B	1.0	A
Total Power Dissipation @ $T_C = 25^\circ\text{C}$ Derate above 25°C	P_D	30 0.24	W W/ $^\circ\text{C}$
Operating and Storage Junction Temperature Range	T_J, T_{STG}	-55 to +150	$^\circ\text{C}$

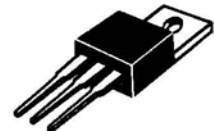

TO-220

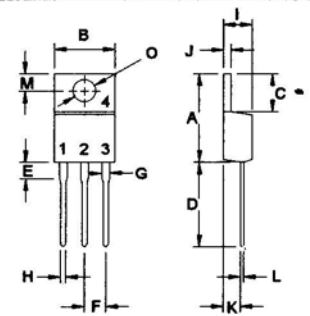

PIN 1.BASE
2.COLLECTOR
3.EMITTER
4.COLLECTOR(CASE)

THERMAL CHARACTERISTICS

Characteristic	Symbol	Max	Unit
Thermal Resistance Junction to Case	$R_{\theta jc}$	4.16	$^\circ\text{C/W}$

DIM	MILLIMETERS	
	MIN	MAX
A	14.68	16.00
B	9.78	10.42
C	5.02	6.60
D	13.00	14.62
E	3.10	4.19
F	2.41	2.67
G	1.10	1.67
H	0.69	1.01
I	3.21	4.98
J	1.14	1.40
K	2.20	3.30
L	0.28	0.61
M	2.48	3.00
O	3.50	4.00

FIGURE -1 POWER DERATING

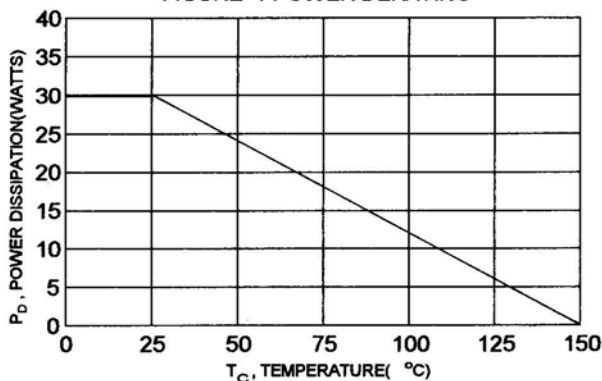

ELECTRICAL CHARACTERISTICS ($T_c = 25^\circ\text{C}$ unless otherwise noted)

Characteristic	Symbol	Min	Max	Unit
----------------	--------	-----	-----	------

OFF CHARACTERISTICS

Collector-Emitter Voltage ($I_C = 10\text{ mA}$, $I_B = 0$)	V_{CE0}	60		V
Collector Cutoff Current ($V_{CB} = 20\text{ V}$, $I_E = 0$)	I_{CBO}		100	μA
Collector Cutoff Current ($V_{CE} = 60\text{ V}$, $I_B = 0$)	I_{CEO}		5.0	mA
Emitter Cutoff Current ($V_{EB} = 4.0\text{ V}$, $I_C = 0$)	I_{EBO}		1.0	mA

ON CHARACTERISTICS (1)

DC Current Gain ($I_C = 1.0\text{ A}$, $V_{CE} = 2.0\text{ V}$) * ($I_C = 0.1\text{ A}$, $V_{CE} = 2.0\text{ V}$)	$h_{FE(2)}$ h_{FE}	40 40	320	
Collector-Emitter Saturation Voltage ($I_C = 2.0\text{ A}$, $I_B = 200\text{ mA}$)	$V_{CE(sat)}$		1.0	V
Base-Emitter On Voltage ($I_C = 1.0\text{ A}$, $V_{CE} = 2.0\text{ V}$)	$V_{BE(on)}$		1.5	V

DYNAMIC CHARACTERISTICS

Current-Gain-Bandwidth Product ($I_C = 0.5\text{ A}$, $V_{CE} = 5.0\text{ V}$, $f = 1.0\text{ MHz}$)	f_T	5.0		MHz
---	-------	-----	--	-----

(1) Pulse Test: Pulse Width $\approx 300\ \mu\text{s}$, Duty Cycle $\leq 2.0\%$ * $h_{FE(2)}$ Classification :

40	C	80	60	D	120	100	E	200	160	F	320
----	---	----	----	---	-----	-----	---	-----	-----	---	-----

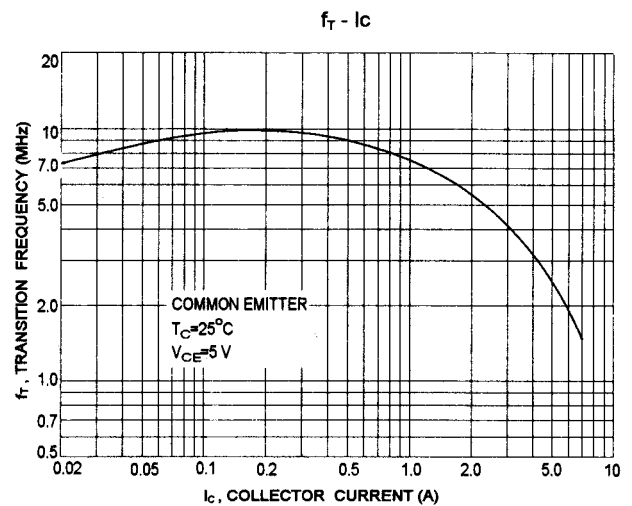
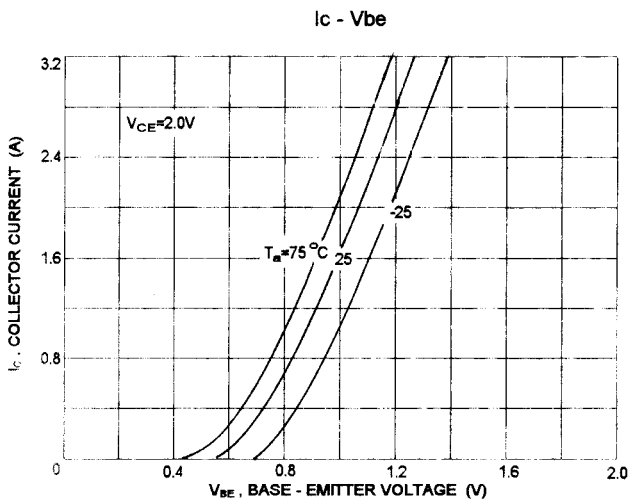
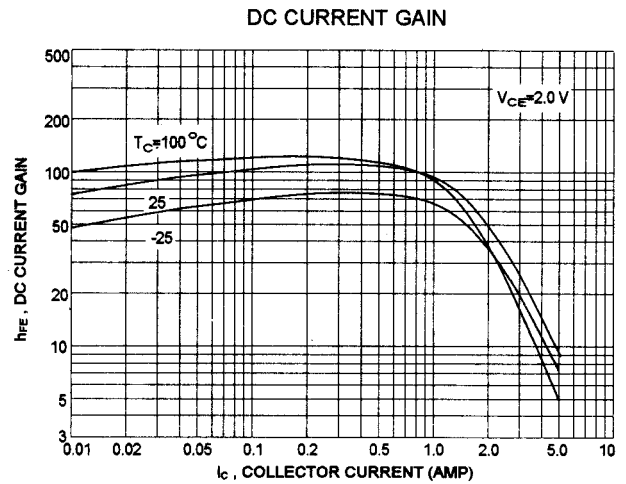
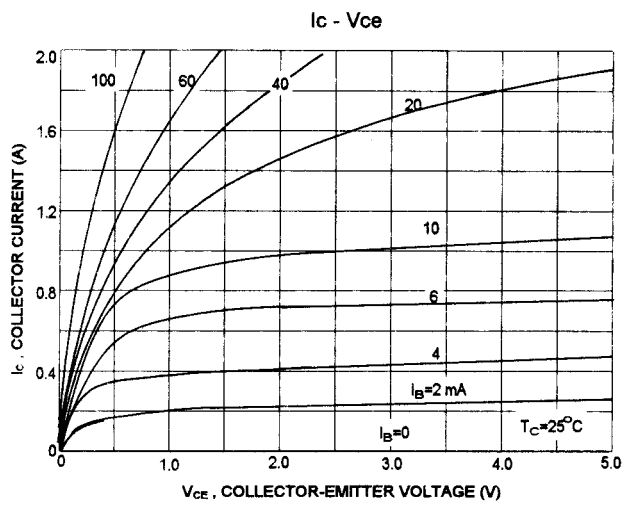

ACTIVE-REGION SAFE OPERATING AREA (SOA)

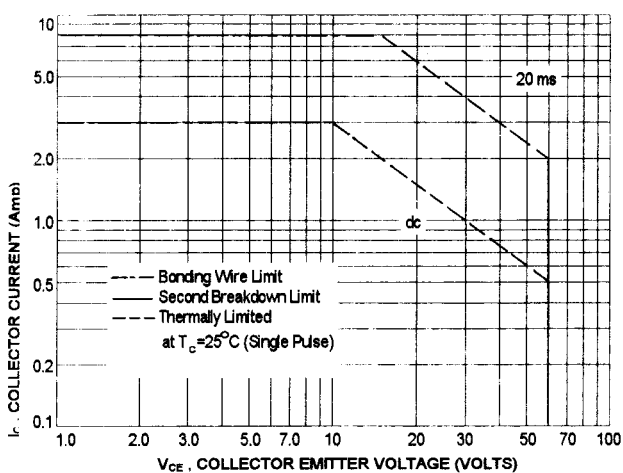

There are two limitations on the power handling ability of a transistor: average junction temperature and second breakdown. Safe operating area curves indicate I_c - V_{ce} limits of the transistor that must be observed for reliable operation, i.e., the transistor must not be subjected to greater dissipation than the curves indicate.

The data of SOA curve is based on $T_{J(PK)} = 150^\circ\text{C}$; T_c is variable depending on conditions. Second breakdown pulse limits are valid for duty cycles to 10% provided $T_{J(PK)} \leq 150^\circ\text{C}$. At high case temperatures, thermal limitation will reduce the power that can be handled to values less than the limitations imposed by second breakdown.

Notice

MOSPEC reserves the rights to make changes of the content herein the document anytime without notification. MOSPEC or anyone on its behalf, assumes no responsibility or liability for any errors or inaccuracies. Please refer to MOSPEC website for the last document.

MOSPEC disclaims any and all liability arising out of the application or use of any product including damages incidentally and consequentially incurred.

Application shown on the herein document are examples of standard use and operation. Customers are responsible for comprehending suitable use in particular applications. MOSPEC makes no representation or warranty that such application will be suitable for the specified use without further testing or modification.

The information contained herein is presented only as a guide for the applications of our products. No responsibility is assumed by MOSPEC for any infringements of patents or other rights of the third parties which may result from its use. No license is granted by implication or otherwise under any patent or patent rights of MOSPEC or others.

These MOSPEC products are intended for usage in general electronic equipment. Please make sure to consult with MOSPEC before you use these MOSPEC products in equipment which require specialized quality and/or reliability, and in equipment which could have major impact to the welfare of human life (atomic energy control, aeronautics , traffic control, combustion control, safety devices etc.)